

DATA SHEET

# TA5212

## Pluggable connector for screw and spring connection

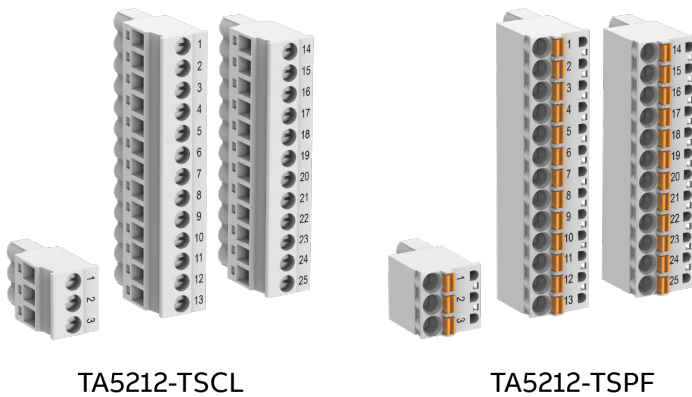

TA5212-TSCL

TA5212-TSPF

### 1 Ordering data

Part no.	Description
1SAP 187 400 R0004	<p>TA5212-TSCL: screw terminal block set for AC500-eCo V3 Standard and Pro CPU</p> <p>screw front, cable side 5.00 mm pitch</p> <ul style="list-style-type: none"> <li>• 1 removable 3-pin terminal block for power supply</li> <li>• 1 removable 13-pin terminal block for I/O connectors</li> <li>• 1 removable 12-pin terminal block for I/O connectors</li> </ul>
1SAP 187 400 R0005	<p>TA5212-TSPF: spring terminal block set for AC500-eCo V3 Standard and Pro CPU</p> <p>spring front, cable front 5.00 mm pitch</p> <ul style="list-style-type: none"> <li>• 1 removable 3-pin terminal block for power supply</li> <li>• 1 removable 13-pin terminal block for I/O connectors</li> <li>• 1 removable 12-pin terminal block for I/O connectors</li> </ul>

## 2 Dimensions

### 2.1 3-pin terminal block for power supply

#### Screw type

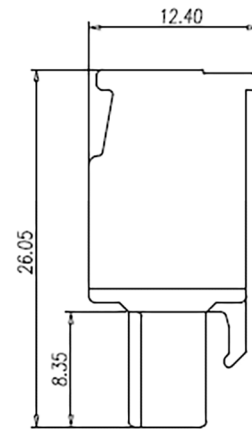
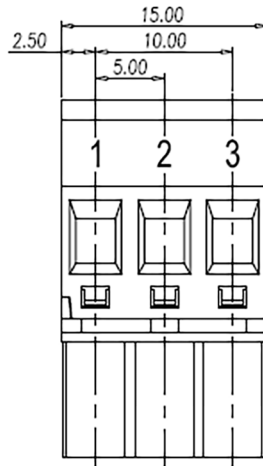
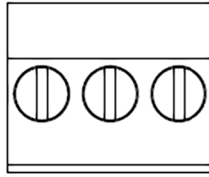

#### Spring type

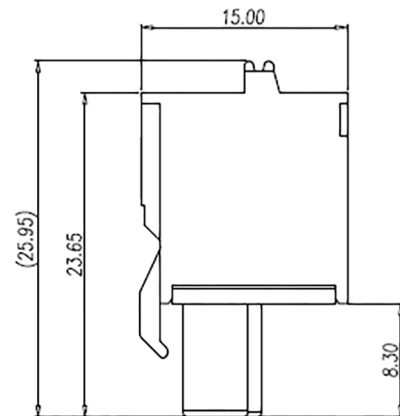
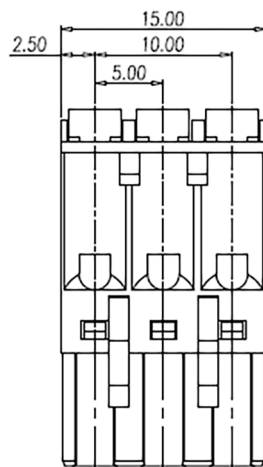
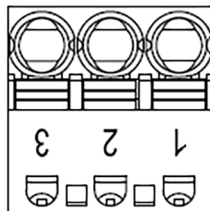

## 2.2 13-pin terminal block for I/O connectors

### Screw type

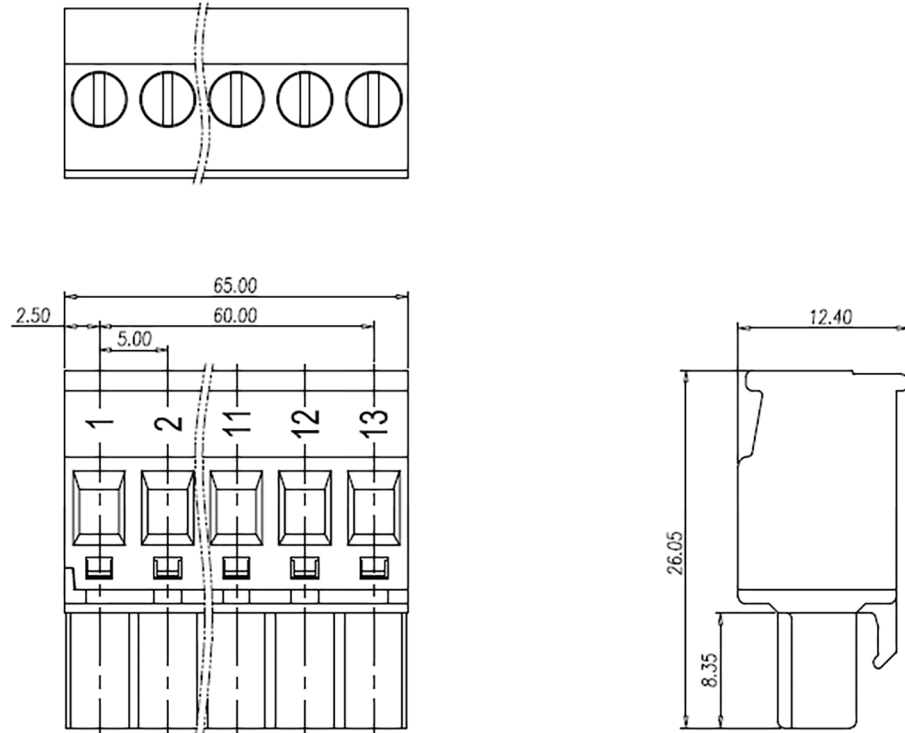

### Spring type

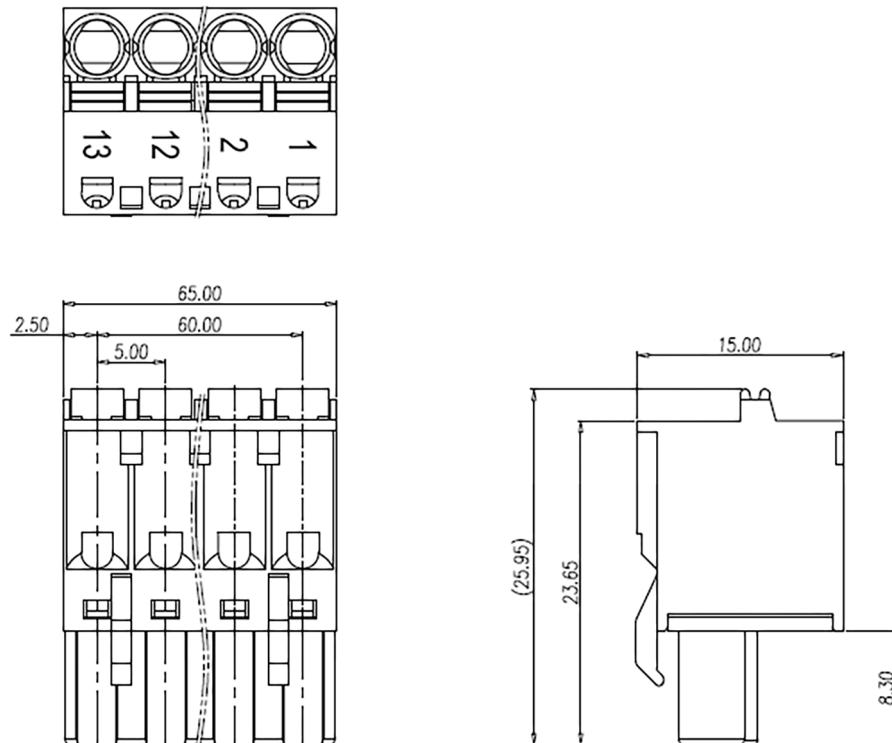

### 2.3 12-pin terminal block for I/O connectors

#### Screw type

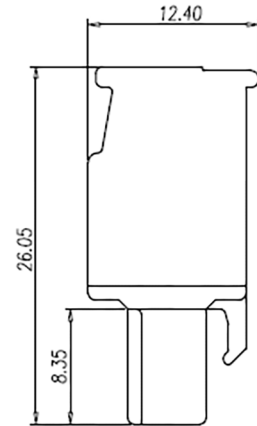
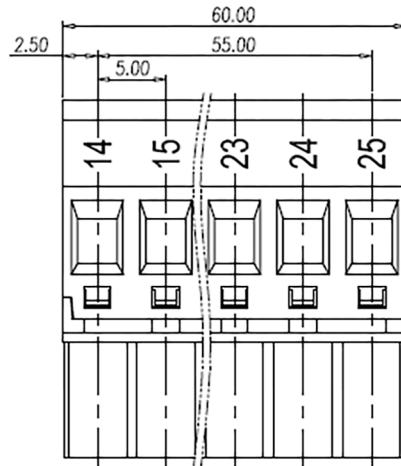
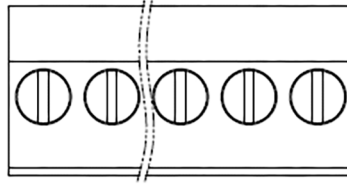

#### Spring type

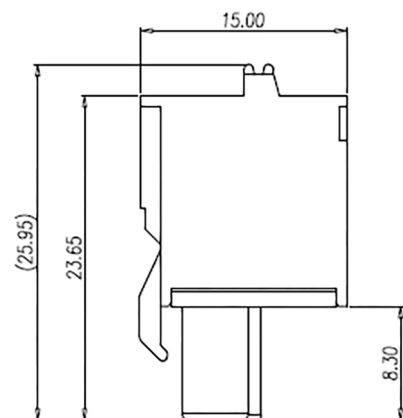
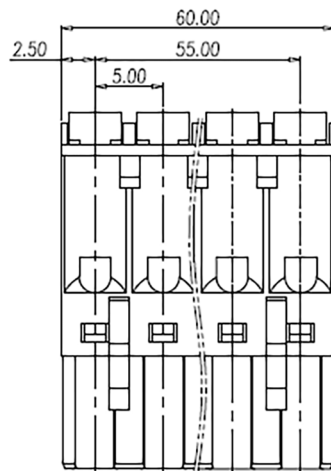
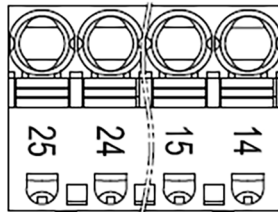

### 3 Technical data

Table 1: Screw type terminal block for power supply

Parameter		Value
Type		
	TA5211-TSCL-B	Removable 3-pin terminal block: screw front/cable side 5.00 mm pitch
	TA5212-TSCL	
Usage		Power supply for AC500-eCo V3 processor modules
Conductor cross section		
	Solid (copper)	0.5 mm <sup>2</sup> ...2.5 mm <sup>2</sup>
	Flexible (copper)	0.5 mm <sup>2</sup> ...2.5 mm <sup>2</sup>
Stripped conductor end		7 mm
Fastening torque		0.5 Nm
Dimensions		
	3-pin terminal block	15 mm x 12.4 mm x 26.05 mm
Weight		
	TA5211-TSCL-B	150 g (2 terminal blocks)
	TA5212-TSCL	200 g (3 terminal blocks)

Table 2: Spring type terminal block for power supply

Parameter		Value
Type		
	TA5211-TSPF-B	Removable 3-pin terminal block: spring front/cable front 5.00 mm pitch
	TA5212-TSPF	
Usage		Power supply for AC500-eCo V3 processor modules
Conductor cross section		
	Solid (copper)	0.5 mm <sup>2</sup> ...2.5 mm <sup>2</sup>
	Flexible (copper)	0.5 mm <sup>2</sup> ...2.5 mm <sup>2</sup>
Stripped conductor end		11 mm
Dimensions		
	3-pin terminal block	15 mm x 15 mm x 25.95 mm
Weight		
	TA5211-TSPF-B	150 g (2 terminal blocks)
	TA5212-TSPF	200 g (3 terminal blocks)

Table 3: Screw type terminal block for onboard I/Os

Parameter		Value
Type		
	TA5211-TSCL-B	Removable 13-pin terminal block: screw front/cable side 5.00 mm pitch
	TA5212-TSCL	Removable 13-pin and 12-pin terminal block: screw front/cable side 5.00 mm pitch

Parameter	Value
Usage	Onboard I/Os for AC500-eCo V3 processor modules
Conductor cross section	
Solid (copper)	0.5 mm <sup>2</sup> ...2.5 mm <sup>2</sup>
Flexible (copper)	0.5 mm <sup>2</sup> ...2.5 mm <sup>2</sup>
Stripped conductor end	7 mm
Fastening torque	0.5 Nm
Dimensions	
13-pin terminal block	65 mm x 12.4 mm x 26.05 mm
12-pin terminal block	60 mm x 12.4 mm x 26.05 mm
Weight	
TA5211-TSCL-B	150 g (2 terminal blocks)
TA5212-TSCL	200 g (3 terminal blocks)

Table 4: Spring type terminal block for onboard I/Os

Parameter	Value
Type	
TA5211-TSPF-B	Removable 13-pin terminal block: spring front/cable front 5.00 mm pitch
TA5212-TSPF	Removable 13-pin and 12-pin terminal block: spring front/cable front 5.00 mm pitch
Usage	Onboard I/Os for AC500-eCo V3 processor modules
Conductor cross section	
Solid (copper)	0.5 mm <sup>2</sup> ...2.5 mm <sup>2</sup>
Flexible (copper)	0.5 mm <sup>2</sup> ...2.5 mm <sup>2</sup>
Stripped conductor end	11 mm
Dimensions	
13-pin terminal block	65 mm x 15 mm x 25.95 mm
12-pin terminal block	60 mm x 15 mm x 25.95 mm
Weight	
TA5211-TSPF-B	150 g (2 terminal blocks)
TA5212-TSPF	200 g (3 terminal blocks)